



SCAN
Multilanguage
Manual

Introduction

The IT700 is an ultra-slim smart thermostat, just 11 mm thick, perfect for heating and cooling control. It uses Zigbee communication, has a rechargeable battery, and includes a magnetic wall plate and a desk stand. It is conveniently integrated in the SALUS Smart Home system.

Product Compliance

This product complies with the essential requirements and other relevant provisions of Directives 2014/53/EU, 2015/863/EU. The full text of the EU Declaration of Conformity is available at the following internet address: www.saluslegal.com.
(CE) 2405-2480MHz; <20dBm (Wifi)

Safety Information

Use in accordance to national and EU regulations. Use the device as intended, keeping it in dry condition. Product for indoor use only. Installation must be carried out by a qualified person in accordance to national and EU regulations. Disconnect your equipment before cleaning it with a dry cloth.

LCD Icon Description

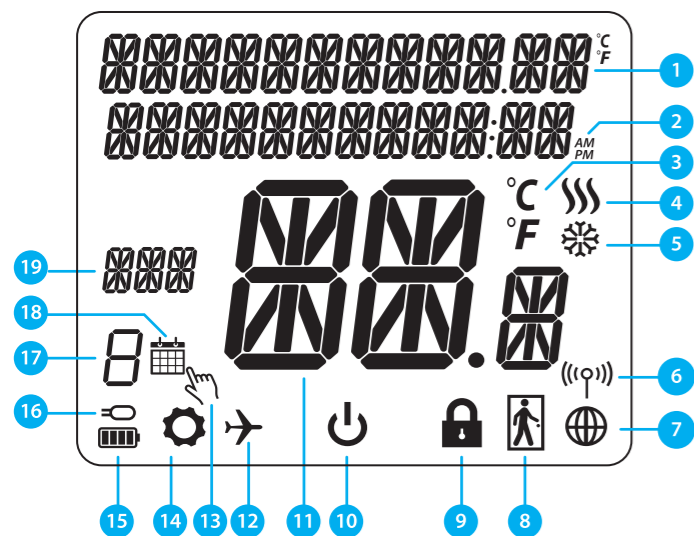

- 1. Menu/Settings description + Clock
- 2. AM/PM
- 3. Temperature unit
- 4. Heating indicator (icon is animating when there is heating demand)
- 5. Cooling indicator (icon is animating when there is cooling demand)
- 6. RF Connection indicator
- 7. Internet connection indicator
- 8. Occupancy sensor (hotel card)
- 9. Key lock function
- 10. Standby mode icon
- 11. Current Temperature / Setpoint Temperature
- 12. Holiday mode
- 13. Temporary override mode
- 14. Settings icon
- 15. Battery status indicator
- 16. External / Floor temp sensor indicator
- 17. Schedule program number
- 18. Schedule mode icon
- 19. Day indicator / SET information

Button	Function
	1) Menu button / Return button. 2) In the MAIN SCREEN: Press and hold for 3 sec to change the thermostat operating mode (Schedule mode / Permanent mode / Temporary override mode). 3) In the SETTINGS SCREEN: Press and hold for 3 sec to go back without saving the changes. 4) In the PAIRING SCREEN (in SYSTEM TYPE Menu): Press and hold for 3 sec to see other pairing options.
	„Down“ Button (Decrease parameter value/moving on the menu in 'DOWN' direction)
	“Up” Button (Increase parameter value/moving on the menu in 'UP' direction)
	1) Press and hold for 3 seconds to POWER UP new device 2) “OK / Tick” Button (Confirm parameter value / Go to the next menu / Save settings) 3) In the MAIN SCREEN: Press and hold for 3 seconds to enter Standby mode 4) In the SETTINGS SCREEN: Press and hold for 3 sec to go back to the MAIN SCREEN & SAVE all the changes. 5) During PAIRING process – hold button for 3 seconds to POWER OFF or REBOOT the thermostat
	In the MAIN SCREEN – press and hold these buttons together for 3 seconds to LOCK / UNLOCK the Thermostat keys).

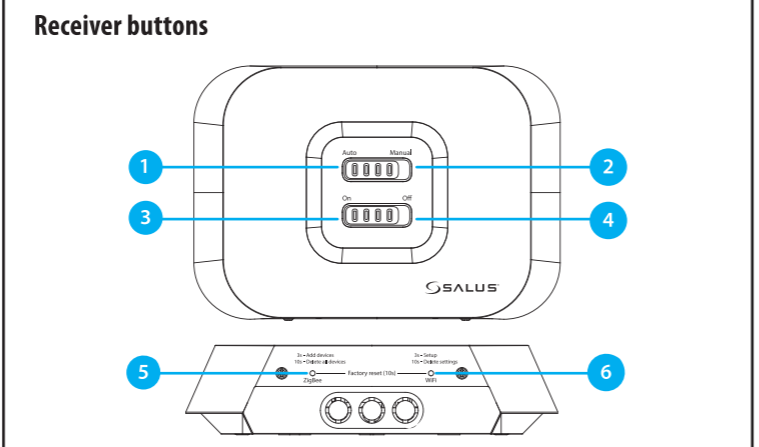

- 1. **AUTO** - Receiver operates in auto mode according to the thermostat.
 - 2. **MANUAL** - Receiver output is controlled by the On/Off slide switch. (Manual ON can be disabled in the App)
 - 3. **ON** - When in Manual Mode, ON will turn the boiler on.
 - 4. **OFF** - Turn the boiler off, whether in Auto or Manual mode
 - 5. **ZIGBEE** - ZigBee network configuration
 - 6. **WIFI** - WiFi network configuration the On/Off slide switch. (Manual ON can be disabled in the App)
- Note:** Press and hold for 10 seconds the ZigBee and WiFi buttons to perform the Factory Reset.

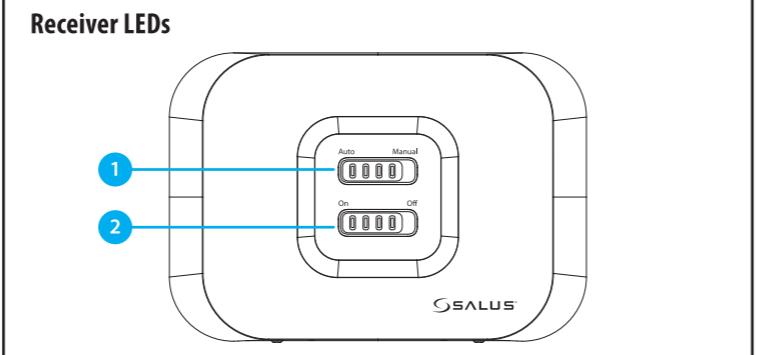

1 AUTO - MANUAL BUTTON	2 ON - OFF BUTTON
Connected to internet	Cool demand
Define internet connection	ZigBee network is open
Internet settings not defined	No heat/cool demand OR No devices linked with receiver
OTA in progress	ZigBee network is in identifying mode
Lost internet connection	When devices is found and added to the network
	Heat demand
	During deleting all paired devices

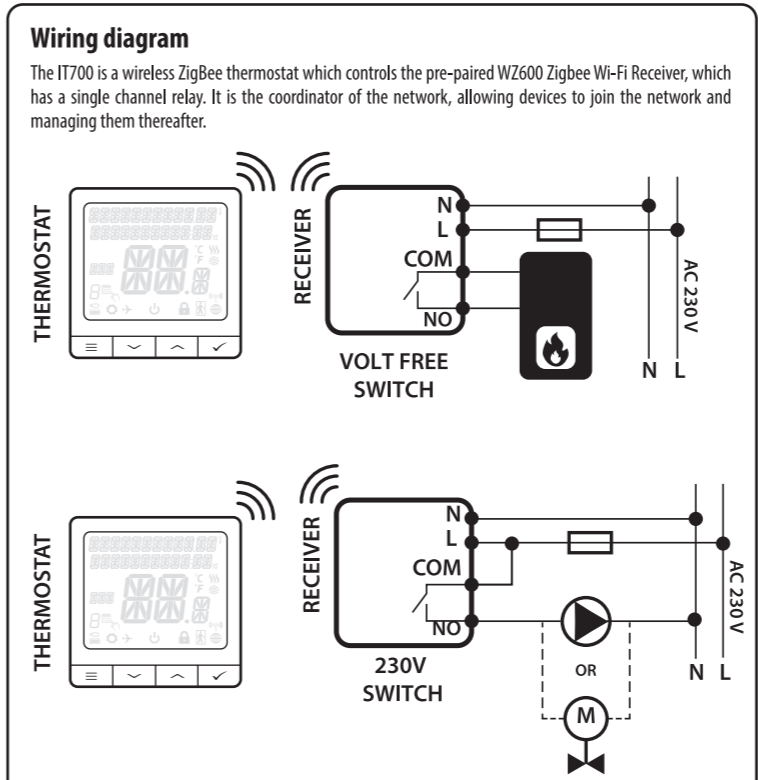

Pairing Process

Note: The thermostat and the receiver arrive pre-paired from the factory. In case you need to pair again, please follow the steps below:

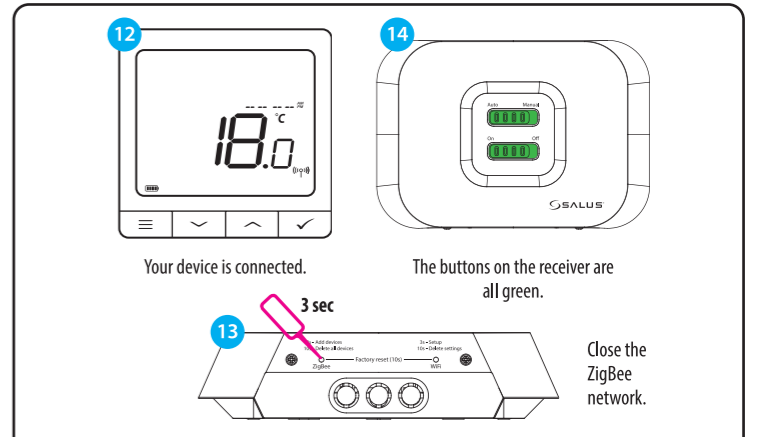
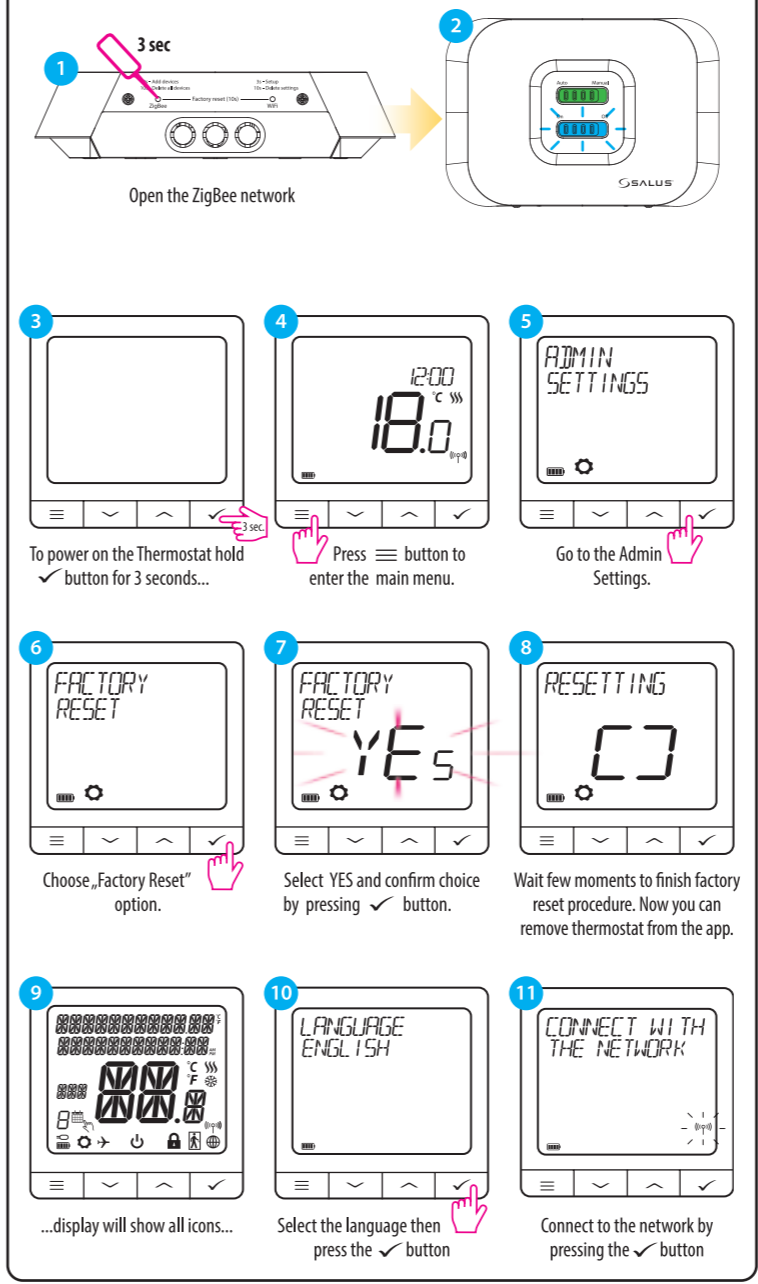

THERMOSTAT FUNCTIONALITIES:

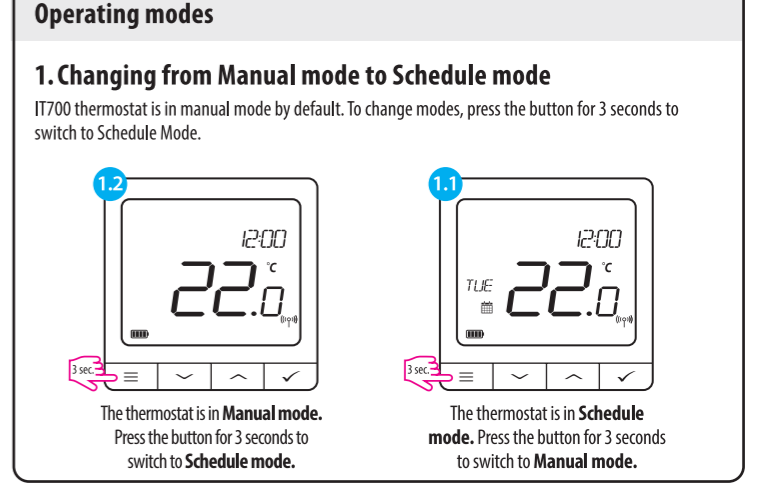
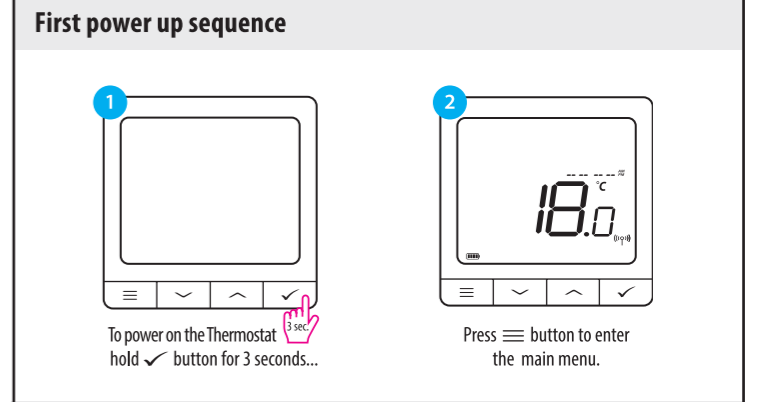

HEAD OFFICE:

SALUS Controls
Units 8-10, Northfield Business Park, Forge Way, Parkgate Rotherham, S60 1SD

SALUS Controls GmbH,
Dieselstrasse 34,
63165 Mühlheim am Main,
Germany

Email: sales@salus-tech.com

www.saluscontrols.com

SALUS Controls is a member of the Computime Group. Maintaining a policy of continuous product development SALUS Controls plc reserve the right to change specification, design and materials of products listed in this brochure without prior notice.

2. Standby mode

STANDBY mode is a special setpoint temperature which can be activated/deactivated in any time. It can work like a frost protection or overheating protection when needed. When standby mode is activated, the clock continues running (although it is not displayed), and the temperature sampling also continues. To enter **STANDBY mode** hold the button for 3 seconds on your thermostat. You can always turn off **STANDBY mode** by holding the button for 3 seconds again.

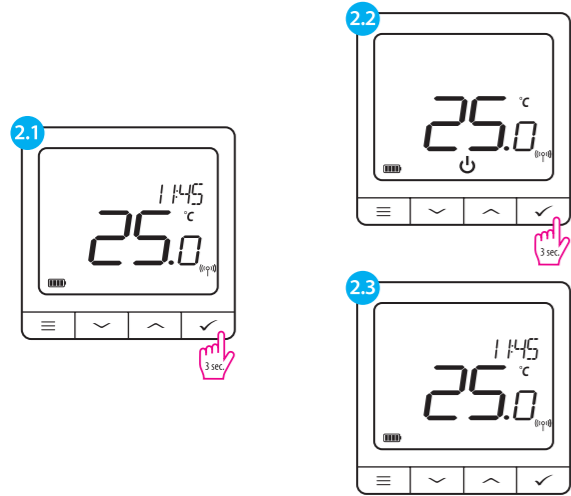

3. Schedule mode

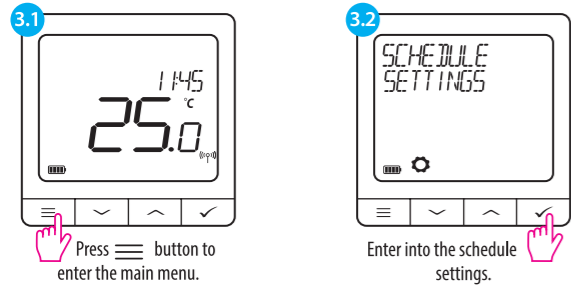

There are 3 possible schedule options. Use or buttons to select schedule variant and confirm by button



Separate schedule for **WORKING DAYS** and separate schedule for **WEEKENDS**
 One schedule for **WHOLE WEEK**
 Seven separate schedules for **SINGLE DAYS**

Schedule programming example for the **WHOLE WEEK** variant:

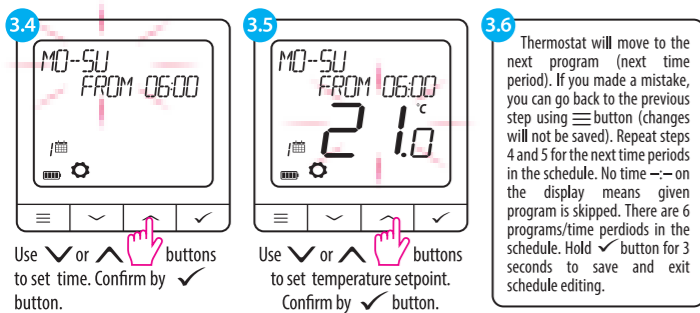

After setting the schedule thermostat is working in schedule mode. You can see calendar icon on the display:

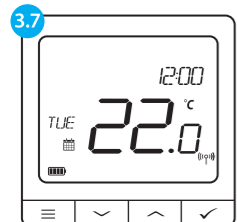

Home screen during Schedule mode

*Default schedule in Offline mode

7 days (Monday to Sunday)		
Program	Time	Temperature
1	6:00	21 °C
2	23:00	19 °C

Heat / Cool Selection

IT700 thermostat can work in heating or cooling mode. To set thermostat operating mode please follow steps below:

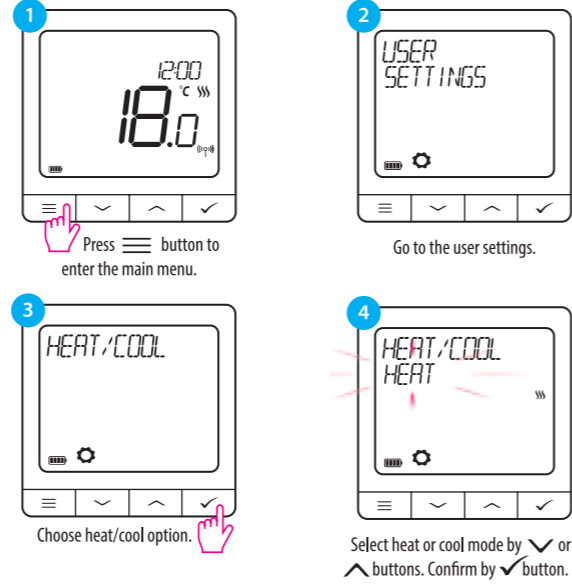

Advanced menu - RF signal

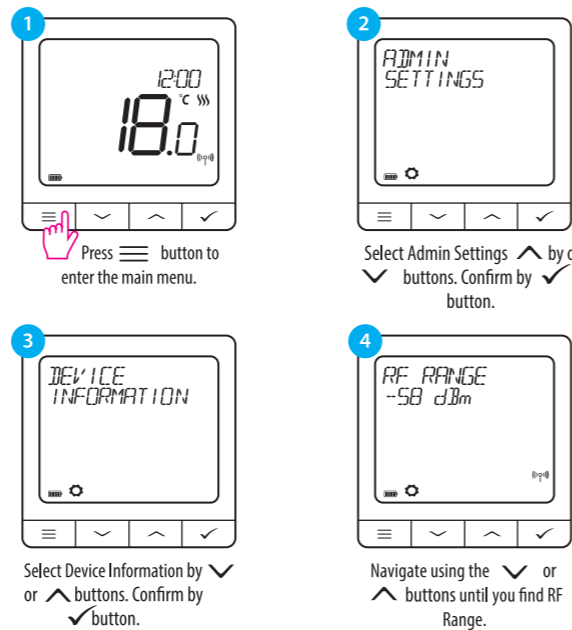

Factory Reset

To **RESET** IT700 thermostat to its factory default settings please follow steps below:

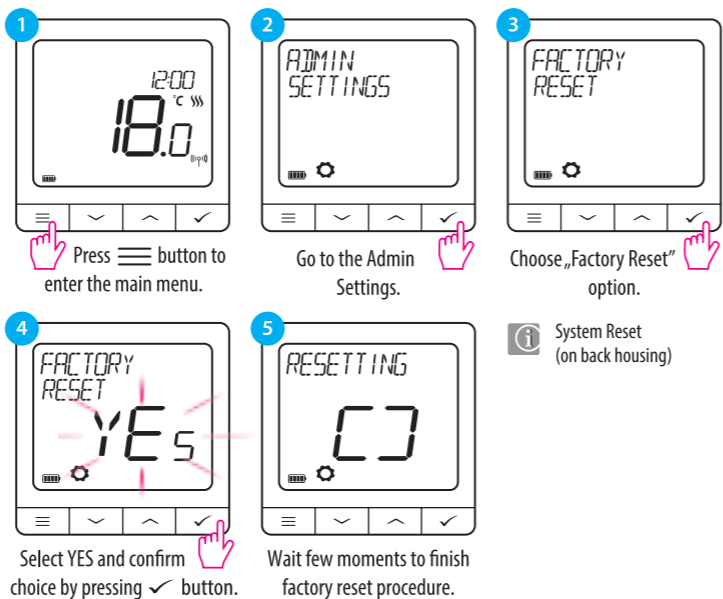

System Reset (on back housing)

Connect your thermostat to the SALUS APP

Installation in Online Mode - Using Bluetooth
 Power on the device, then follow these steps to gain control via the Salus Premium Lite app.

